

Performance Comparison of Blind and Non Blind Adaptive Beamforming Algorithms in Mobile Communication

Roshni Thakur¹, Koushal Singh Mourya²

¹(Department of Electronics and Communication, PCST, Indore/ RGPV Bhopal, India)

²(Department of Electronics and Communication, MIST, Indore/ RGPV Bhopal, India)

Abstract: The adaptive beamforming system emerged as leading technology which becomes capable to locate and track signals by both: users and interferers and dynamically adapts the antenna pattern to enhance the reception in Signal-of-Interest (SOI) direction and minimizing interference in Signal-Not-of-Interest (SNOI) direction. Adaptive beamforming is used for enhancing a desired signal while suppressing noise and interference at the output of an array of sensors. This paper analyzes the performance and compares one of the Non Blind Algorithm- Recursive Least Square (RLS) with a commonly used Blind algorithm - Constant Modulus Algorithms CMA which do not require any temporal reference for the computation of the optimal weight vectors on various performance parameters of mobile communication system. The simulation results of both Blind-RLS and Non Blind-CMA shows that their performance improves with more elements in the array, with large snapshots of signals, greater angular separation between the signals. The analysis parameter used for comparison of above algorithms are response towards beam forming which shows that Recursive Least Square gives much improved results than CMA by giving a perfect null towards the direction of interferer signals.

Keywords: Adaptive beam forming, Blind algorithm and Non Blind algorithm, Smart Antenna.

Date of Submission: 18-11-2017

Date of acceptance: 30-11-2017

I. Introduction

As the growing demand for mobile communications is constantly increasing, the need for better coverage, improved capacity, and higher transmission quality rises. Thus, a more efficient use of the radio spectrum is required. Beam forming systems are capable of efficiently utilizing the radio spectrum and are a promise for an effective solution to the present wireless systems problems while achieving reliable and robust high-speed, high-data-rate transmission. In fact, beam forming systems comprise several critical areas such as individual antenna array design, signal processing algorithms, space-time processing, wireless channel modeling and coding, and network performance. [1, 2] To overcome the shortcoming, a more advanced method was developed. This method, usually called the optimum beam forming technique, fully utilizes the spatial diversity present in the multipath channel so that a stronger received signal can be generated. With optimum beam forming, signals received from multiple antennas are adjusted separately in both amplitude and phase before being combined. By doing so, the system behaves as if it has multiple adjustable radiation patterns. Each of the patterns is tuned to receive signals from a single user. An adaptive algorithm is used at the base station so that the system has the ability to determine the optimal radiation pattern for each user. [10, 11].As part of the training procedure, each of the users transmits a short training sequence to the base station. The algorithm then makes use of this information from a user by comparing each received signal to the original sequence to find out the correct radiation pattern for that user. With this method, all received signals from each antenna element are used and are optimally combined to enhance the desired signal and to cancel unwanted interference. During the training process, a lot of number crunching is needed at the base station. So it was not popular in the past due to the expensive cost of computation power. However, intensive signal processing is no longer an issue with the availability of low cost, extremely fast processors. It is more complicated when interference from other mobile occurs.[1,2]

II. Adaptive Beamforming Algorithm

There are many types of adaptive beam forming algorithms. Fig (1) shows the adaptive beam forming system. Most of the beam forming algorithms can be categorized under two classes according to whether the training signal is used or not. These two classes are non blind adaptive algorithms and blind adaptive algorithms. Non blind adaptive beam forming algorithms uses a training signal $d(t)$ to update its complex weight vector. This training signal is sent by the transmitter to the receiver during the training period. Beam forming in the receiver uses this information to compute new complex weight. LMS, NLMS, RLS and DMI algorithms are categorized as non blind algorithms. Blind algorithms do not require any training sequence to update its

complex vector. Constant Modulus Algorithm (CMA) and Decision Directed (DD) algorithms are examples of blind beam forming algorithms. These algorithms use some of the known properties of the desired signal.

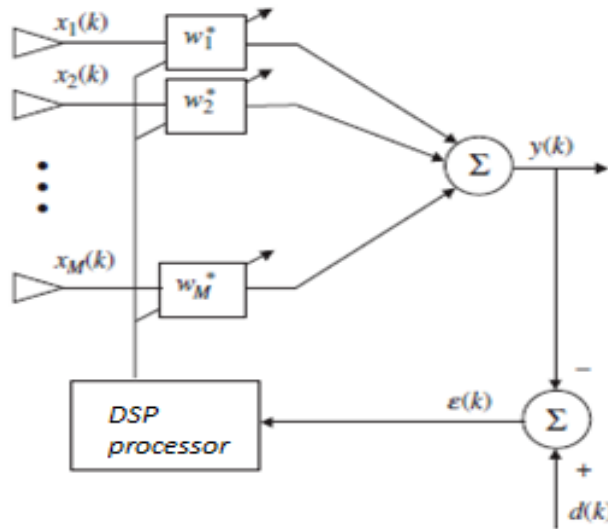

Fig. 1. Showing adaptive processing of Antenna array system [3].

III. Recursive Least Square Algorithm

Recursive least squares (RLS) algorithm is used in adaptive filters to find the filter coefficients that relate to recursively producing the least squares (minimum of the sum of the absolute squared) of the error signal (difference between the desired and the actual signal). The RLS method is not a steepest descent technique, but rather an iterative, approximate solution to a least square problem. Because it is an approximate LS method, it typically offers much faster convergence than other method. This is contrast to other algorithms that aim to reduce the mean square error. The difference is that RLS filters are dependent on the signals themselves, whereas MSE filters are dependent on their statistics (specifically, the autocorrelation of the input and the cross-correlation of the input and desired signals). The idea behind RLS filters is to minimize a cost function C by appropriately selecting the filter coefficients, updating the filter as new data arrives. The error signal $e(n)$ and desired signal $d(n)$ are defined in the negative feedback diagram below:

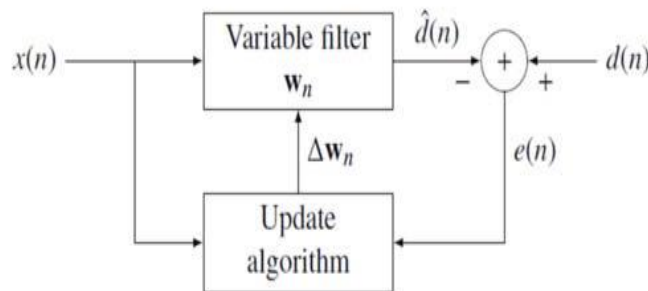

Fig. 2. Recursive Least Square block Diagram [3]

Implementation of the RLS algorithm

The least mean square algorithm is a gradient based approach.

The error is given by

$R^{-1}(0) = \delta^{-1}I$, δ small positive constant and

I the $N \times N$ identity matrix

For each k

$$\begin{cases} f(k) = R^{-1}(k-1)x(k) \end{cases} \quad (1)$$

$$g(k) = \frac{f(k)}{\lambda + x^H(k)x(k)} \quad (2)$$

$$R^{-1}(k) = \frac{[R^{-1}(k-1) - [f(k)k^H(k)]]}{(\lambda + x^H(k) + g(k))} \quad (3)$$

$$e(k) = d(k) - w^H(k) x(k) \quad (4)$$

$$w(k+1) = w(k) + e(k) g(k) \quad (5)$$

}

Where λ is the forgetting factor, it is also called exponential weighting factor. Its value is such that, $0 \leq \lambda \leq 1$ which shows that it is a positive constant. $\lambda = 1$ indicates infinite memory and also ordinary least square algorithm is restored. RLS has faster rate of convergence than other algorithms, this enhanced performance is achieved at the expense of huge computational complexity side lobes and has narrowest beam width. [1,3]

IV. Constant Modulus Algorithm

CMA is a well known algorithm of adaptive beamforming of blind adaptation and is used in many practical applications because it does not require carrier synchronization. This can be applied successfully to non-constant modulus signals if the kurtosis is less than two. This means that the CMA can be applied to, for example, PSK signals that have non-rectangular pulse shape. This is important because this implies that the CMA is also robust to symbol timing error when applied to pulse-shaped PSK signals. This algorithm is derived keeping in view the constant complex envelope (amplitude) property of the signal. These signals generally include FM, FSK, PSK, QAM and PAM. If the arriving signal has constant amplitude then this algorithm maintains and restores the amplitude of desired signal. The weights can be calculated using following equations.

For each k

{

$$y(k) = w^H(k) x(k) \quad (6)$$

$$e(k) = \frac{y(k)}{|y(k)|} - y(k) \quad (7)$$

$$w(k+1) = w(k) + \mu e^*(k) x(k) \quad (8)$$

}

Where $x(k)$ = input data vector, $w(k)$ = weight vector, $e(k)$ = error signal and μ = step size. Although CMA does not require a pilot signal but it has a major drawback of slow convergence.

The blind equalization problem requires a slightly different approach to calculate the error. In constant modulus algorithm the error is calculated based upon the statistics of the transmitted signal and the filter output [5].

$$y(n) = \hat{w}(n)^H u(n) \quad (9)$$

$$e(n) = d(n) - y(n) \quad (10)$$

$$\hat{w}(n+1) = \hat{w}(n) + \mathbb{E} u(n) e^*(n) \quad (11)$$

$$y(n) = \hat{w}(n)^H u(n) \quad (12)$$

$$e(n) = \hat{y}(n) [R_2 - |\hat{y}(n)|^2] \quad (13)$$

$$\hat{w}(n+1) = \hat{w}(n) + \mathbb{E} u(n) e^*(n) \quad (14)$$

$$R_2 = \frac{E \{ |a(n)|^2 \}}{E \{ |a(n)|^2 \}} \quad (15)$$

The algorithm itself involves a repeated iteration over equations 12, 13, 14 and 15. The filtering operations shown in equations 9 and 12, along with the filter adjustments in equations 11 and 14 are identical. The essence of this algorithm is in the calculation of the filtering error. The function is designed to minimize deviations from constant statistics. As the system converges, the difference between the filter output and R_2 goes to zero. The filtered received signal then becomes a lagged constant phase change of the original transmitted signal. The Constant Modulus Algorithm can be used extremely effectively for the cancellation of noise due to multipath propagation. [1, 3, 10]

V. Analysis And Comparative Study

MATLAB tool has been used for the simulation of RLS and CMA adaptive beamforming algorithms. Simulation has been run to analyze the RLS algorithm we give the following parameters:

Number of elements in linear smart antenna: 8.

The spacing d (in lambda) between adjacent elements: 0.5

The Pilot signal (SOI) amplitude: 1

Received signal arriving (in degree): 30

Interferer angle (in degree): -60

K (No. of Samples) = 500

1. Amplitude Response with complex weights for RLS

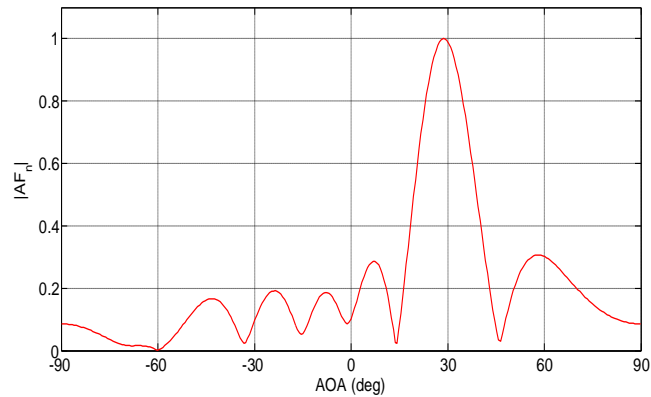

Fig3. Amplitude response with complex weights for RLS

2. Comparison of amplitude response of RLS Algorithm at $d = 0.5\lambda$, varying no. of Elements (N)

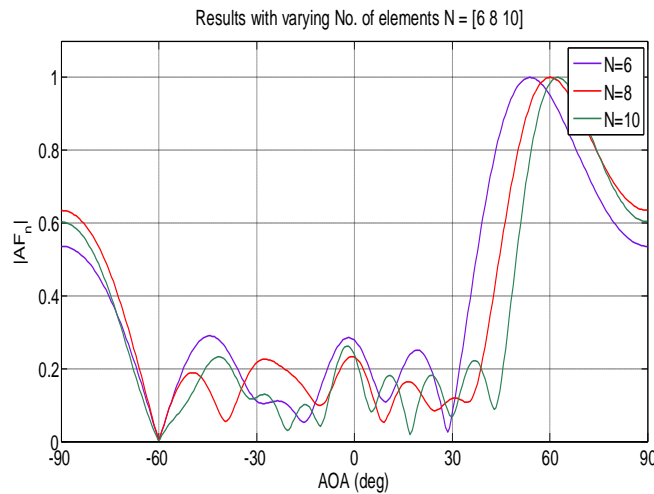

Fig 4. Linear Array beamforming Pattern at $d = 0.5$ & $N = 6, 8$ and $= 10$

3. Comparison of amplitude response of RLS Algorithm at $N = 8$, varying space element (d).

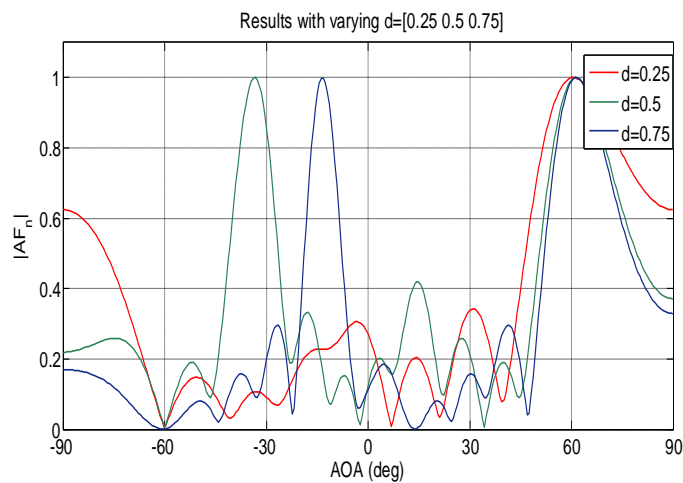

Fig 5. Linear Array beamforming Pattern at $N = 8$ and $d = 0.25, 0.5$ and 0.75

4. Comparison of amplitude response of RLS Algorithm at $N = 8$, varying no. of samples (k).

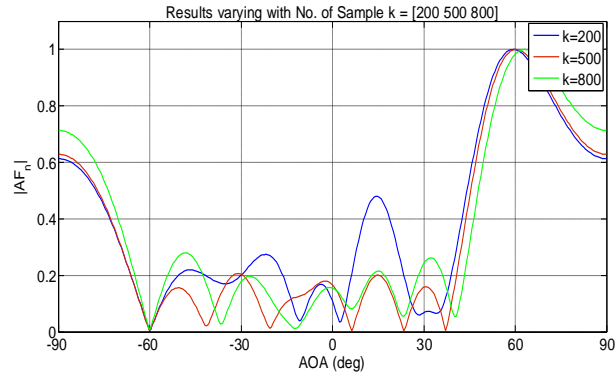

Fig.6. Linear Array beamforming Pattern at $N = 8$, at $k = 200, 500 \text{ \& } 800$

The comparison of amplitude response of RLS algorithm in fig. 4 in terms of linear array beamforming pattern at fixed distance between elements and varying no. of antenna elements i.e. $d=0.5 \lambda$ and $N = 6, 8$ and 10 . The best result was obtained at $N=10$ i.e. sharp major lobe is at 60° and perfect null at -60° . In fig 5 varying distance between the elements i.e. $N= 8$ and $d= 0.25 \lambda, 0.5 \lambda$ and 0.75λ . The best results were obtained at $d=0.5$ and varying no. of samples at $k= [200, 500 \text{ and } 800]$. The best results were obtained at $k=800$ as shown in fig 6.

Simulation results for CMA algorithm obtained from the same parameters are as follows-

1. Amplitude Response with complex weights for CMA

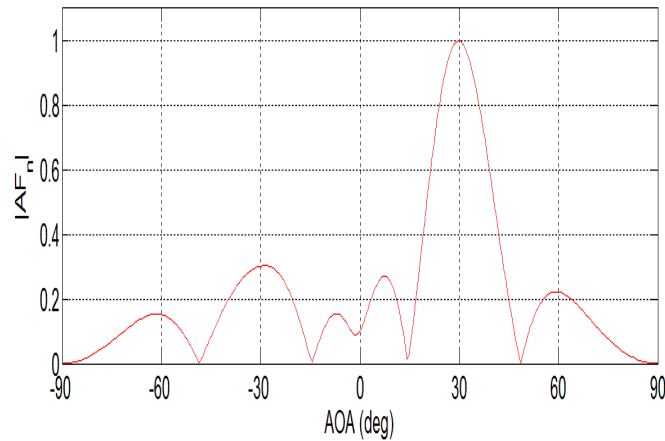

Fig.7. Amplitude response with complex weights for RLS

2. Comparison of amplitude response of RLS Algorithm at $d = 0.5\lambda$, varying no. of Elements (N)

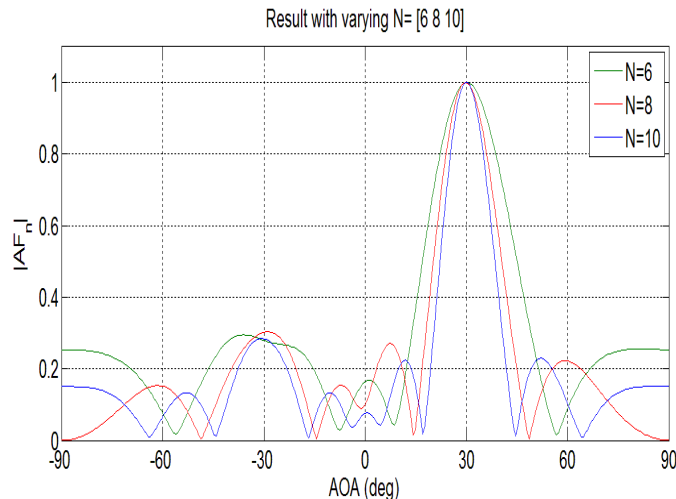

Fig 8.. Linear Array beamforming Pattern at $d = 0.5 \text{ \& } N = 6, 8 \text{ and} = 10$

3. Comparison of amplitude response of CMA Algorithm at $N = 8$, varying space element (d).

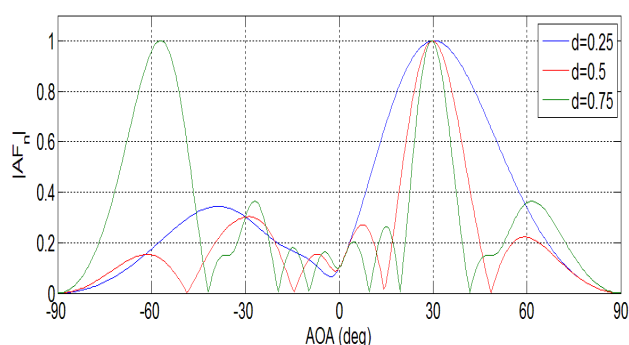

Fig.9. Linear Array beamforming Pattern at $N = 8$ and $d = 0.25, 0.5$ and 0.75

The comparison of amplitude response of CMA algorithm in fig.7 in terms of linear array beamforming pattern at fixed distance between elements and varying number of antenna elements i.e. $d=0.5 \lambda$ and $N = 6, 8$ and 10 . The best result was obtained at $N=10$ i.e. sharp major lobe is at 60° and however poor null at -60° . In fig 8 varying distance between the elements i.e. $N= 8$ and $d= 0.25 \lambda, 0.5 \lambda$ and 0.75λ . The best results were obtained at $d=0.5$ and varying no. of samples at $k= [200,500$ and $800]$. The best results were obtained at $k=800$ as shown in fig 9.

The two algorithms when compared on the basis of their radiation pattern as shown in Fig.10. It can be seen that the sharpness and the preciseness in the radiation pattern are better in the case of RLS algorithm.

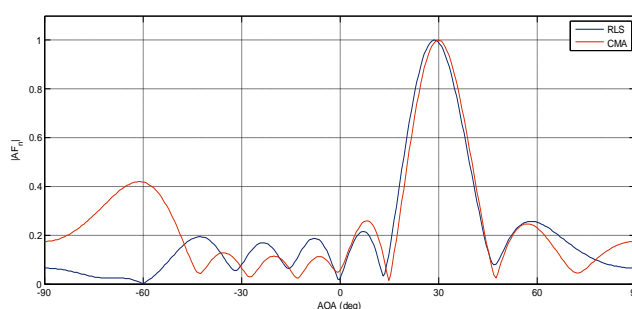

Fig. 10 Comparison of RLS & CMA in terms of Radiation Pattern

Conclusion

The simulation results of both the algorithms RLS and CMA shows that their performance improves with more elements in the array, with large snapshots of signals, greater angular separation between the signals. The Recursive Least Square and Constant Modulus Algorithm steer their beam towards desired direction. It is also of great importance the pattern should give a perfect null towards the direction of interferers. The Recursive Least Square give a perfect null on the Angle of arrival of interferer, but CMA shows poor results for the same. This shows that Recursive Least Square gives much more improved results than CMA by giving a perfect null towards the direction of interferer signals. CMA algorithm converges slower than RLS.

References

- [1]. Muhammad Salman Razzaq and Noor M. Khan "Performance comparison of adaptive beamforming algorithm for smart antenna system" World Applied Sciences Journal 11(7) IDOSI Publications, 2010.
- [2]. A. Udawat, Dr. P.C. Sharma, Dr. S. Katiyal "Performance Analysis and Comparison of Adaptive Beamforming Algorithms for Smart Antenna Systems" Next Generation Networks, 2010 International Conference on 24-25 Sept. 2010.
- [3]. A. Udawat, Dr. P.C. Sharma, Dr. S. Katiyal, "Comparison of Optimization Capabilities of RLS Adaptive Beamforming Algorithm for Smart Antenna Systems", Proceedings of the 5th National Conference; INDIACOM- March 2011
- [4]. S.F. Shaaukat, R. Farooq & Z. Saleem "Sequential studies of beamforming algorithms for smart antenna systems" World Applied Science Journal 6(6) IDOSI Publications, 2009.
- [5]. Ch. Santhirani, Dr. P.V. Subbaian & Dr. K. Chennakesava Reddy "Smart antenna algorithms for WCDMA mobile communication systems" IJCSNS Vol. 8 No. 7, July 2008.
- [6]. T. Bao Vu, "Smart Antenna System Architecture and Hardware Implementation", 2008

- [7]. R.S.Kawitkar and D.G Wakde “Smart antenna array analysis using algorithm”, IEEE Int. symposium M.Chrysomallis, ”Smart antennas”
- [8]. J. Zhang, “The adaptive algorithms of the smart antenna system in future mobile telecommunication systems”, IEEE, 2015.
- [9]. S.Gazor and K.Shahtalebi, “A new NLMS algorithm for slow noise magnitude variation”, IEEE Signal processing Letter, Vol.9, NO.11, , 2012.
- [10]. Constatine A. Balanis & Panayiotis. I. Ioannides “Introduction to smart antennas”Morgan and Claypool publishers, 2007,Page No. (134-200).
- [11]. Nur Alina Zureen Bt Rosli & Politeknik Seberang Perai “Simulation of a smart antenna system” PSP’s Research Digest.
- [12]. Simon Haykin, — “Adaptive filter theory”, Forth edition, Pearson education Asia, Second Indian reprint, 2002.
- [13]. Bernard widrow, Samuel D. Stearns, — “Adaptive signal processing”, Pearson education asia, Second Indian reprint, 2002.

IOSR Journal of Electronics and Communication Engineering (IOSR-JECE) is UGC approved Journal with SI. No. 5016, Journal no. 49082.

Roshni Thakur"Performance Comparison of Blind and Non Blind Adaptive Beamforming Algorithms in Mobile Communication." IOSR Journal of Electronics and Communication Engineering (IOSR-JECE), vol. 12, no. 6, 2017, pp. 51-57.